

ISO 9001:2015



Machinery Directive Number 1674



經濟部創新研究獎
Taiwan Enterprises Innovation Award

眾程科技全系列產品 Full Series of Products



2017 16th
台中市金手獎
Taichung SMEs Golden Hand Award



2017 & 2018
國家品牌玉山獎
National Brand Yushan Award



創新設計
金炬獎
Innovative And Customer Satisfaction



29th
精品銀質獎
Taiwan Excellence Silver Award



2018 21th
小巨人獎
The Rising Star Award



2018
中區傑出經理
2018 Outstanding Manager of Central Region



2018
國家傑出經理
2018 National Outstanding Manager



2023 16th
研發創新佳作
2023 The Winners of Taiwan Machine Tools Industry



眾程簡介

- 1988 成立眾程機械股份有限公司，專業生產高精密平面磨床。
- 1995 推出 1020 & 1224 三軸全自動 ASD 系列磨床，同時獲得 英國 AMTRI CE-MARK 安全驗證。
- 1997 導入 ISO 9002 國際品保驗證專案執行，全面推行 ISO 品保運動。
推出 2448 & 2480 三軸全自動智慧型數位控制 ADX 系列磨床，突破自動進刀在 μM 以下進行障礙，領先推出 0.5 μM 超微米量進刀，為產業升級。
- 1998 通過 荷蘭 DNV ISO 9002 國際品保認證。
- 2001 通過貝爾 ISO 9000 國際品保驗證。推出 NC 智慧型數位控制磨床。
- 2003 2000 版 ISO 9001 國際品保驗證。推出 ASD II 數值控制平面磨床；ACUMEN 奈米級伺服控制磨床、砂輪自動修整補償系列磨床。
- 2005 NC 平面成型磨床，榮獲  台灣精品獎。新款立式綜合加工機 EMV 1100 1200 1400 量產。
德國分公司正式成立，並推出 EMV 860 / 1020 機型。
- 2006 推出 ETM 510APC 自動交換工作台鑽孔攻牙中心機以及龍門式磨床 1500X3000~1500X5000 等系列機型。
- 2007 於十月加入友嘉集團，展現眾程新時代的經營里程碑。
- 2012 開發動柱型磨床 600X1200~600X2000 MM 之系列機型。
- 2013 規矩共構 SBIR 科專、液靜壓主軸、液靜壓導軌等計畫執行。
推出 EMV-600APC 自動交換工作台；並於同年推出小型龍門磨床。
- 2017 台北國際工具機展 (TIMTOS 2017)1224-TD PLUS、EG-36 CNC、ERG-600CNC 人機協同控制器，以工業 4.0 示範線多機協同作業實機操作應用。
鄧白氏中小企業精英獎 / 第十四屆國家品牌：傑出企業玉山獎 / 台中市第十六屆績優中小企業：金手獎
中華民國傑出企業管理人協會第十八屆金峰獎：十大傑出創業楷模 / 十大傑出創新研發
- 2018 推出 TD PLUS, ADC, 1224CNC, 818CNC, 818CNC+CAD/CAM, 84CNC 及 104CNC 等高精密系列機型磨床。
中華民國傑出企業管理人協會第 14 屆金炬獎：十大企業優良顧客滿意度 / 創新設計獎 TD PLUS (ADC) 智慧型高精密平面磨床。
第 15 屆國家品牌玉山獎最佳產品類 TD-PLUS(ADC)
第 24 屆 中部地區中小企業 傑出總經理獎
第 36 屆 國家中小企業 傑出總經理獎
第 21 屆經濟部中小企業小巨人獎 / 第 25 屆中小企業創新研究獎 TD-PLUS(ADC) 智慧型精密平面磨床
- 2019 推出液靜壓龍門磨床，1200X2000~1200X5000MM 之系列機型；榮獲台灣優良商標。
- 2020 台灣精品獎 TD / ADC 智能化精密平面磨床
- 2021 台灣精品獎 ERG 高精密旋轉台磨床 / 第 29 屆 台灣精品銀質獎 ERG 高精密旋轉台磨床
台灣精品獎 CAD/CAM 磨床新世代控制系統 / TD 系列智慧磨床，累積銷售達 2500 台以上。
- 2022 第 30 屆 台灣精品獎 TDNC 先進智能平面磨床，累計全系列磨床銷售總量 10000 台以上。
- 2023 第 16 屆工具機研究發展創新產品其他數控工具機及其加工單元類佳作獎
- 2024 TMBA 工具機產業銀色節能標章：ERG-600TDNC 液靜壓式旋轉台磨床 / ESG-1224TDNC 精密平面磨床
- 2025 創新開發 EVDG-800 立式圓筒磨床、EVU-818 立式超音波磨床，並以「眾智成程·滴水穿石」之理念，獨家設計自有品牌的智能工具機 -- 創新優化機門飾板，行銷口碑佳評如潮。
- 2026 台中市卓越創新獎，ESG-1224 CNC 節能磨床銀標章、AI 智慧節能、AI 賦能金標章



AI賦能產品 ESG-1224CNC 創新智慧財產權

專利名稱	專利日期	專利國家 案號/證號	取得核准	
			發明	新型
具自動量測高度研磨加工機台	2024	GP-08790		✓
具自動量測高度之研磨加工機台	2024	GP-08789	✓	
具檢知功能之研磨機過濾系統及其方法 2024/10/17領證	2024	112133305 GP-08769	✓	
研磨機過濾系統及其過濾方法 2024/10/17領證	2024	112133306 GP-08768	✓	
切削液調節裝置	2023	M649430GP-08767		✓
研磨機台之砂輪校正裝置2024/3/18領證	2024	I838680 GP-08302	✓	
具檢測系統之研磨機台2024/3/18領證	2023	I838684 GP-08303	✓	
用於研磨機台之智能警示燈裝置	2022	M626171		✓
具電性控制之磨床節流裝置	2019	M578208 GP-07590		✓
具保護結構之磨床加工檔定程裝置	2019	M578632 / GP-07589		✓



超值選配 Wifi 智能工作燈 Ultra value OPT Wi-Fi smart work light



傳統製造業的管理盲點與痛點



資訊延遲 (Information Latency)

生產資訊延遲，管理者無法即時掌握進度



被動反應 (Reactive Management)

產線異常反應不及，導致生產損失



高昂成本 (High Costs)

傳統紀錄方式繁瑣，人工成本高昂



數據失真 (Data Inaccuracy)

靠手工記錄，數據不準確



降低成本 (Reduce Costs)

減少人工與
紙本浪費

EZ-SmartLED Tower：軟硬體整合的解決方案



Wi-Fi 連線

免花大錢架設實體線，安裝快速。



專屬軟體

數據資料永久存在工廠內部，確保資安。



多平台支援

透過電腦或手機隨時查看生產狀況。



快速反應 (Fast Reaction)

異常處理速度
+50%



智慧報表中心：一鍵匯出，告別紙本



提升效率
(Increase Efficiency)
即時發現瓶頸

搜尋介面
(Search Interface)

Start Date: 2024-06-01 End Date: 2024-06-01

Machine: M1, M2, M3, M4

EmployeeName: Name_M2, Name_M3, Name_M5

Program: Product_M2, Product_M3, Product_M5

Reset Filter

N DAY Search

1 Week Search



報表清單
(Data List)

Export (.csv to file)

日期	機台	機台名稱	開始時間	結束時間	程式時間	生產數量
2024-06-01	M1	WORK	14:33:25	14:37:25	00:04:00	1
2024-06-01	M2	HOLD	14:37:55	14:39:25	00:01:30	0
2024-06-01	M2	HOLD	14:39:55	14:45:55	00:06:00	1
2024-06-01	M3	WORK	14:46:25	14:50:55	00:04:30	1
2024-06-01	M4	HOLD	14:50:25	14:57:25	00:07:00	1
2024-06-01	M5	WORK	15:08:25	15:02:25	00:06:00	1
2024-06-01	M5	HOLD	15:10:56	15:10:26	00:00:30	1
2024-06-01	M5	WORK	15:18:56	15:24:56	00:06:00	1
2024-06-01	M6	HOLD	15:25:26	15:24:56	00:00:30	1
2024-06-01	M2	ALARM	15:45:26	17:30:58	01:45:32	0
2024-06-01	M4	OFFLINE	17:31:28	23:59:59	06:28:31	0



多維度搜尋
(Search by Date/Machine)



CSV 匯出
(Export to Excel)



自動生成日報/週報
(Auto Daily/Weekly Reports)



數據決策
(Data-Driven)
憑據準確
報表管理

生產線現場即時觀察：打造您的戰情中心

管理者透過電視牆隨時掌握進度

EZ-SmartLED Tower

2025/04/01 13:52:31

機台	待機	加工	異常	開機
CNC122A	141	146	19696	330
M214	0	0	0	0
M215	0	0	0	0
M216	0	0	0	0
M217	0	0	0	0

正常運作 (Work)

異常警報 (Alarm)

待機/閒置 (Hold)

即時顯示持續時間
(e.g., 00時00分09秒)



手動系列 / 油壓系列

MANUAL / HYDRAULIC SERIES



UF-618 / UF-618M ; UF-818 / UF-818M

ESG-618 / ESG-618M ; ESG-818 / ESG-818M

UF / ESG-618 手動機型 (工作台配合耐磨片滑動)

UF / ESG-618M / 818M 手動機型 (工作台跑珠式)

- 1 A : 左右軸全自動磨床
- 2 A : 左右軸 + 前後軸全自動磨床
- 3 A : 左右軸 + 前後軸 + 砂輪上、下快速昇降

ASD II : 三軸自動磨床數值顯示控制設定, 昇降採用步進馬達做定寸功能。

TDNC : PLC伺服控制 10" 人機介面觸控面板。



專利型鋼絲齒型皮帶傳動機構：輕巧的工作台採用高精密之滑軌及嚴格篩選之鋼珠所組成，移動輕快平穩，滑道可確保長久耐用。

符合人體工學，可調整的工作手輪機構便利使用者操作。

專利型鋼絲齒型皮帶傳動機構：鞍座和底座滑道採雙V型，工作台和鞍座滑道採一V和一平，兩者皆附加耐磨滑片(TURCITE-B)做為滑動介面，經過精密劃花處理，確保平滑運動和卓越的精準度。



English Version 中文版

Innovation Perfection Technology Value

創新設計 追求完美 引導科技 創造價值



ESG-1A618 / ESG-1A818
ESG-2A618 / ESG-2A818
ESG-3A618 / ESG-3A818

ESG-1A1020 / ESG-2A1020 / ESG-3A1020
ESG-2A1224 / ESG-3A1224
ESG-3A1228 / ESG-3A1236
ESG-3A1632 / ESG-3A1640

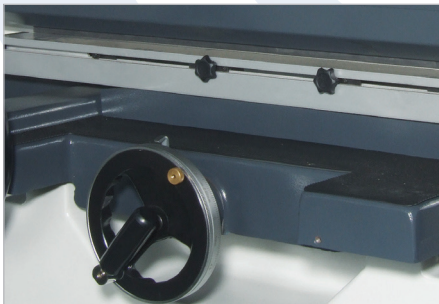

左右換向機構，安全性特佳採用無接點感應開關，調整距離時相當便利。

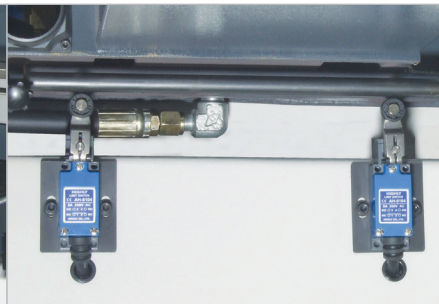

2A, 3A 機型的前後換向機構



橫向滑動採雙V系統，確保精度穩定

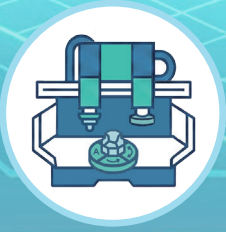

EVDG 立式圓筒磨床



內藏式主軸 A
Spindle A

刀庫
Magazine

工作台
Table

修砂
Dressing

結構 (底座)
Structure(Base)

內藏式主軸 B
Spindle B

螺桿
Screw

0.1um 回授光學尺
Linear scale

結構 (立柱)
Structure (column)

線軌
Guideway

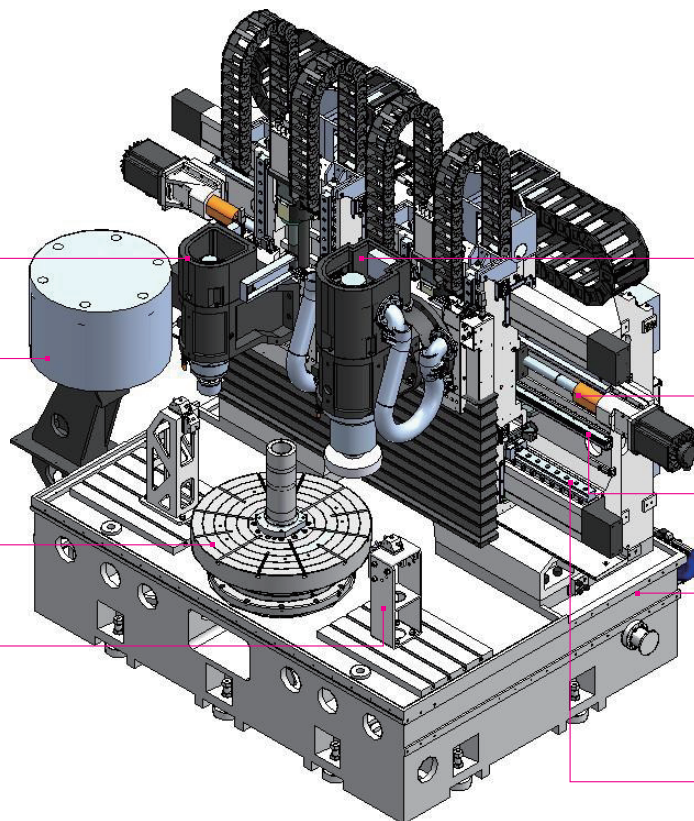



立式內藏主軸(A / B)

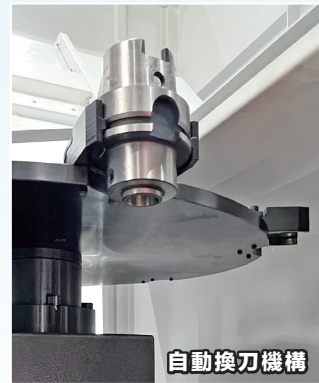

自動換刀機構



智能化自動修砂補償

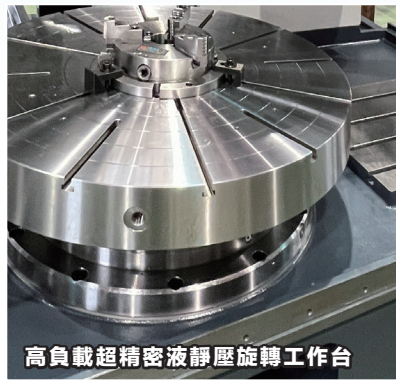

高負載超精密液靜壓旋轉工作台



監控溫升、振動智慧潤滑
預診壽命的智慧螺桿



- 使用繪圖功能，導入 DXF 圖檔生成砂輪及工件
- 3D CAD / CAM 平面研磨成型軟件
- 沖子成形圖面快速對話視窗



TDNC 伺服控制



工具機產業節能銀標章

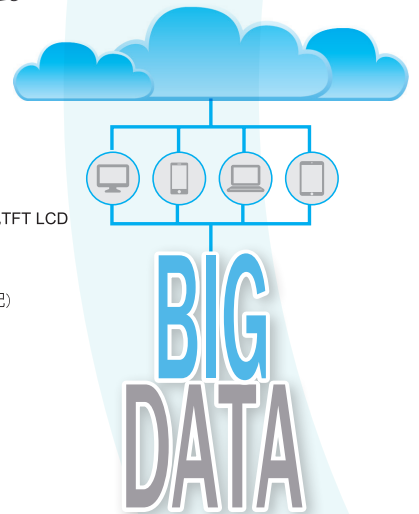

手動動平衡設定畫面 (選配功能)



大數據資料庫



砂輪線速度轉速對照表

砂輪直徑	3000	3500	4000	4500	5000	5500	6000	6500	7000
120	3005	3505	3850	4075	4320	4504	5009	5348	
150	2546	2971	3183	3387	3608	3820	4244	4456	
180	2121	2476	2655	2830	3006	3183	3537	3714	
200	1863	2174	2329	2466	2640	2795	3095	3261	
225	1497	1748	1872	1998	2122	2247	2497	2621	
250	1252	1461	1565	1670	1774	1879	2087	2192	
300	1076	1255	1345	1435	1524	1614	1793	1883	
350	843	1000	1079	1158	1236	1315	1472	1551	
400	740	879	949	1020	1091	1162	1309	1389	1469
450	661	774	836	899	964	1028	1162	1248	1311

警報提示及跑馬燈

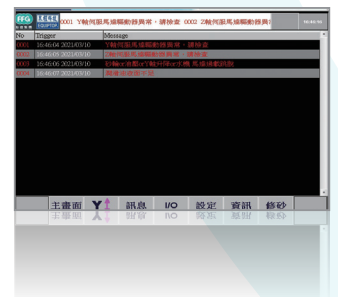



English Version 中文版

Innovation Perfection Technology Value

創新設計 追求完美 引導科技 創造價值



ESG-818 TDNC



ESG-1020TDNC / ESG-1224TDNC



ESG-1632TDNC / ESG-1640TDNC



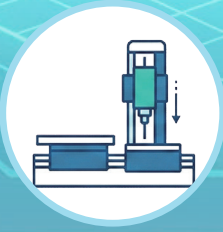

TDNC / CNC 動柱式



輪頂自動砂整補償系統 (選配)

ESG-2448 TDNC
ESG-2460 TDNC / ESG-2480 TDNC

ESG-24120 TDNC / ESG-3260 TDNC
ESG-3280 TDNC / ESG-32120 TDNC



磁力控制 (選配)

觸控式 10.4" 彩色 TFT LCD



Z 軸行程設定

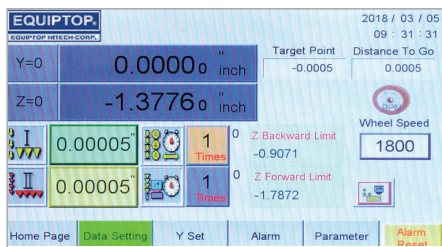
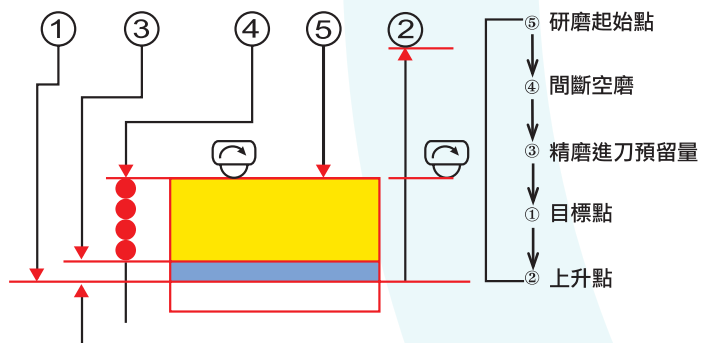

工件研磨條件尺寸設定

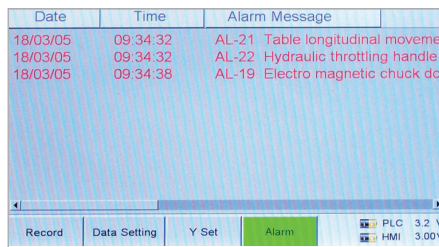

異常訊息警示畫面，藉以故障排除



系統使用者管理畫面，參數設定管理



Innovation Perfection Technology Value

創新設計 追求完美 引導科技 創造價值

English Version 中文版



CNC
ESG-2480 CNC



TDNC
ESG-3280 TDNC

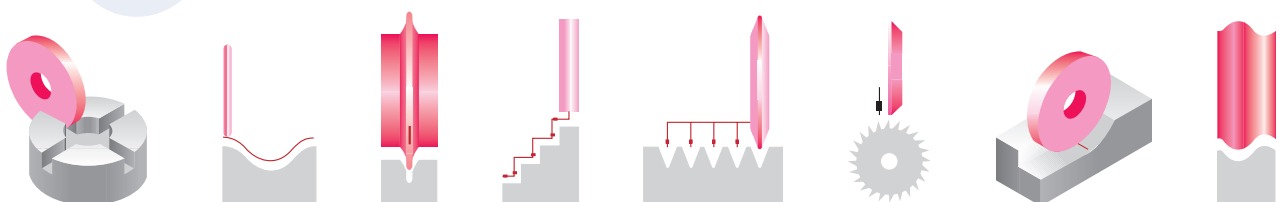



ESG-NC 滾柱型 / CNC 滾珠型

滾柱型 ESG-64CNC / 84CNC / 104CNC

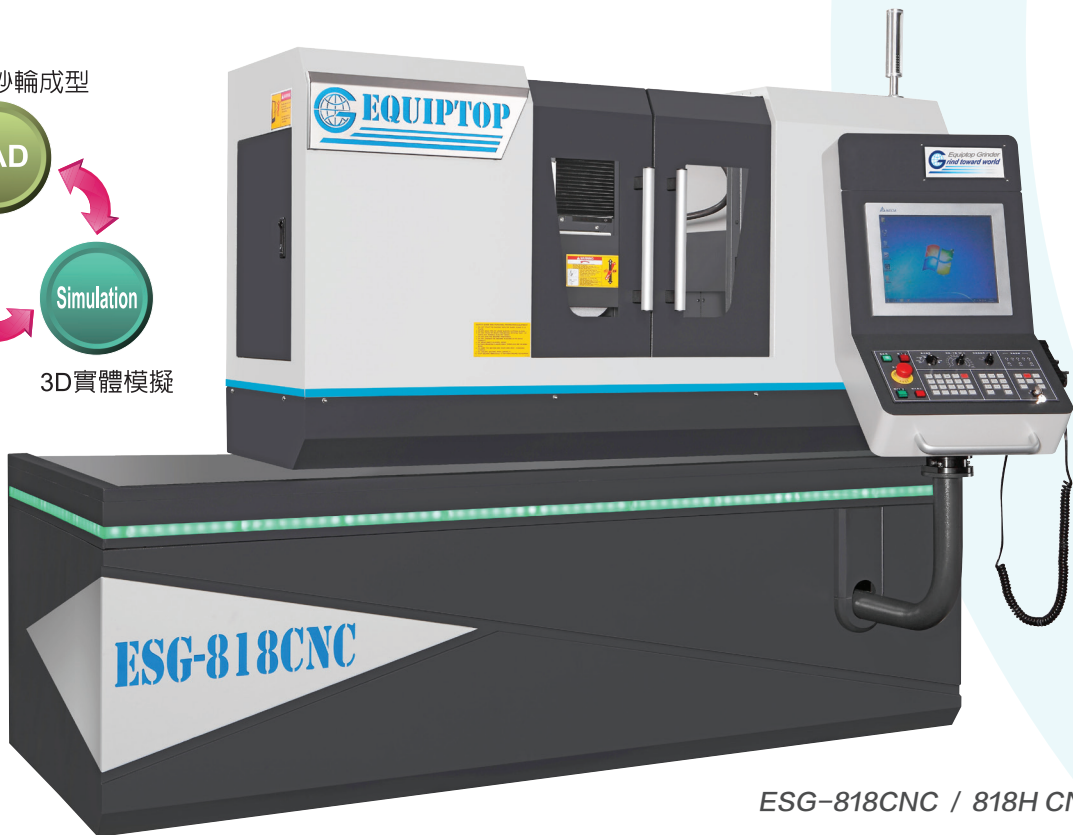
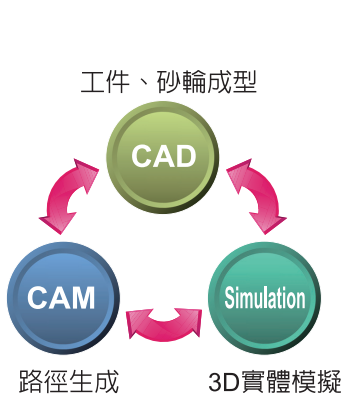

ESG-818CNC / 818H CNC



English Version 中文版

Innovation Perfection Technology Value

創新設計 追求完美 引導科技 創造價值



滾珠型 ESG-1224CNC / 1228CNC



工具機產業 AI 賦能金標章



工具機產業 節能銀標章

前門飾板 (選配)

下襯裙 (選配)



精密級線性導軌
高剛性滾珠型導軌

矩形工作台底座

共構式架構底座

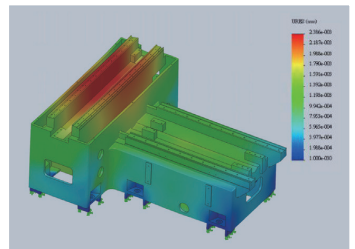
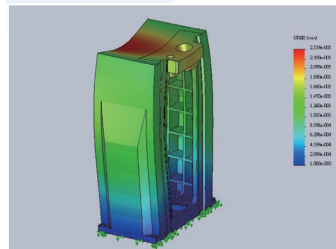
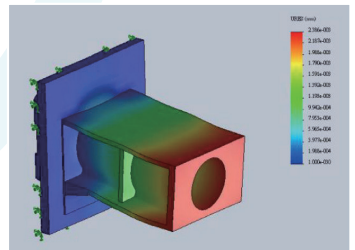
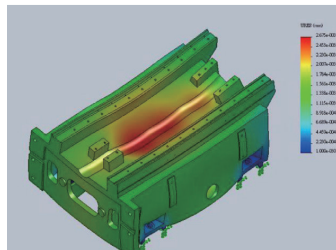
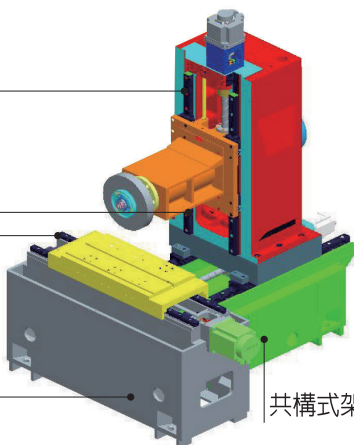



ERG 系列 / ERG-TDNC 系列

液靜壓臥軸高精密旋轉台磨床 / 直結式傳動高刚性 SP 級線性滑軌

ERG-500 / ERG-600 / ERG-800 / ERG-1000



<p>08:49:43</p> <p>工作座標 Y 000.000 Z 000.000</p> <p>機械座標 Y 000.000 Z 000.000</p> <p>Y_G55平面 000.000 Z_G55平面 000.000</p> <p>① Y起點點 ② 距離預留點 ③ 目標點 ④ 回昇點 ⑤ Z1起點點</p> <p>平面研磨 Y起點點 0.000 距離預留點 0.000 目標點 0.000 回昇點 0.000 Z1起點點 0.000 Z2起點點 0.000</p> <p>主畫面 研磨設定 訊息 I/O 設定 資訊 修砂設定</p>	<p>異向壓馬達驅動器異常, 請檢查驅動器代碼 0002 Z軸向壓馬達驅動器 09:05:02</p> <table border="1"> <tr> <th>工作座標</th> <th>剩餘量</th> <th>機械座標</th> </tr> <tr> <td>Y 000.000</td> <td>Y 000.000</td> <td>Y 000.000</td> </tr> <tr> <td>Z 000.000</td> <td>Z 000.000</td> <td>Z 000.000</td> </tr> </table> <p>50 μm 1200 rpm 1.20 mm 1 1 OFF B-servo OFF</p> <p>5 μm 1500 rpm 150 mm 1 1 OFF</p> <p>STOP 加工模式 主軸 0000 rpm 00.0 A 0000 rpm 正常</p> <p>G60手動 0000 rpm 00.0 A 0000 rpm 正常</p> <p>主畫面 研磨設定 訊息 I/O 設定 資訊 修砂設定</p>	工作座標	剩餘量	機械座標	Y 000.000	Y 000.000	Y 000.000	Z 000.000	Z 000.000	Z 000.000	<p>機台 I/O 監視</p> <ul style="list-style-type: none"> 200.0 Y軸Encoder A相 200.1 Y軸Encoder B相 200.2 Z軸Encoder A相 200.3 Z軸Encoder B相 200.4 B軸Encoder A相 200.5 B軸Encoder B相 200.6 Z軸限位開關 200.7 預留 200.8 Y軸 Z相信號 200.9 Z軸 Z相信號 200.10 手軸A相 200.11 手軸B相 200.12 Y軸HOME信號 200.13 Z軸HOME信號 200.14 Y軸上極限開關 200.15 油靜壓冷卻機正常信號(正常為ON) <p>主畫面 研磨設定 訊息 I/O 設定 資訊</p>
工作座標	剩餘量	機械座標									
Y 000.000	Y 000.000	Y 000.000									
Z 000.000	Z 000.000	Z 000.000									

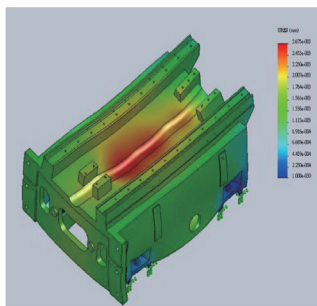

底座位移分析

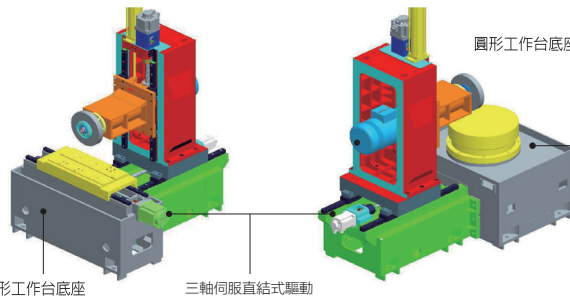

矩形工作台底座 三軸向服直結式驅動

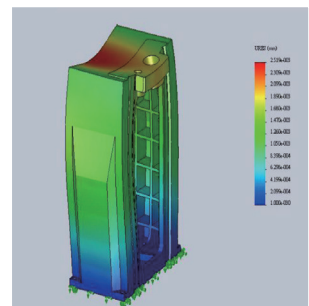

動柱位移分析

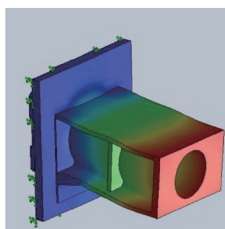

主軸座位移分析

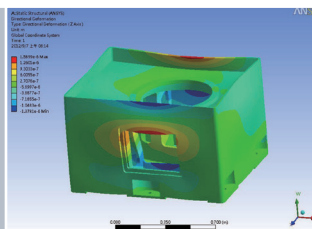

座位分析結果 (Z方向變形)

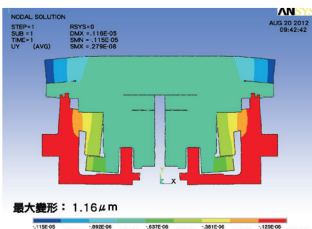

旋轉盤分析結果 (轉盤Y方向變形)

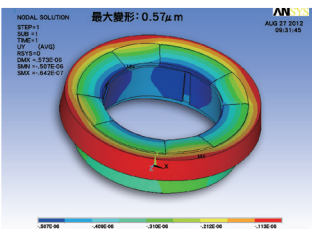

方向變形Y圓盤導軌 (旋轉盤分析結果)



English Version 中文版

Innovation Perfection Technology Value

創新設計 追求完美 引導科技 創造價值



工具機產業節能銀標章

前門飾板 (選配)



- 創新等限速度：專利號碼新 M454893 號
- 採用液靜壓旋轉盤，透過以油體為介質減少對結構產生的磨耗，降低傳統旋轉盤因滾珠式旋轉軸作動所造成之加工誤差，藉以提高加工精度與穩定度並擁有更高的承載量與壽命。(旋轉台為液靜壓式)
- 配合控制器之應用，砂輪自動修整補正值可達 100nm(0.001mm) 的極高精度 (輪頂伺服修整補償機構為選配)。

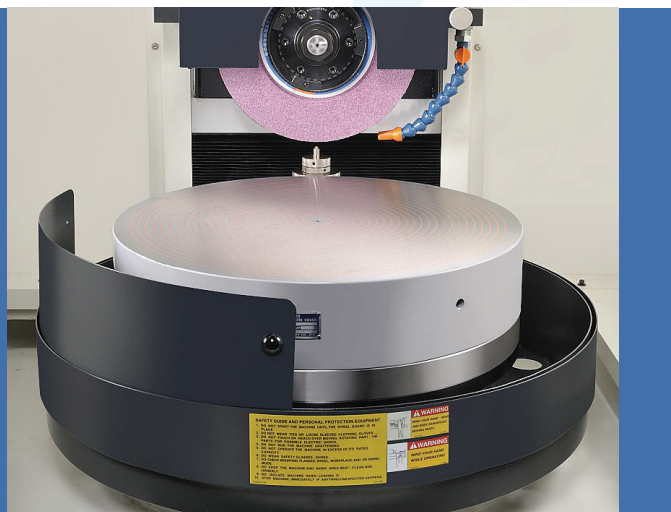



EDG 龍門系列

EDG-10200 / 10250 / 10300 / 10400 / 10500

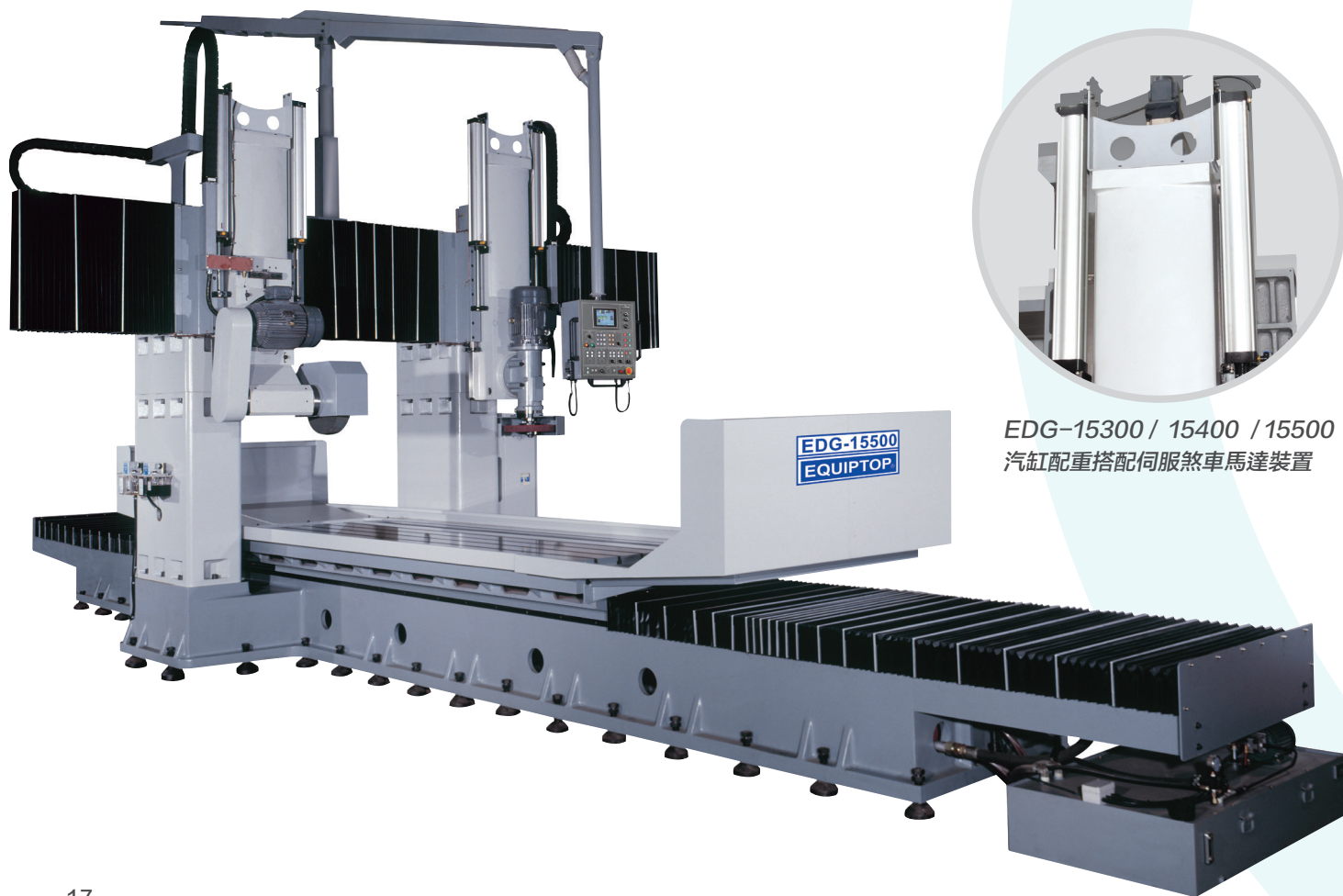
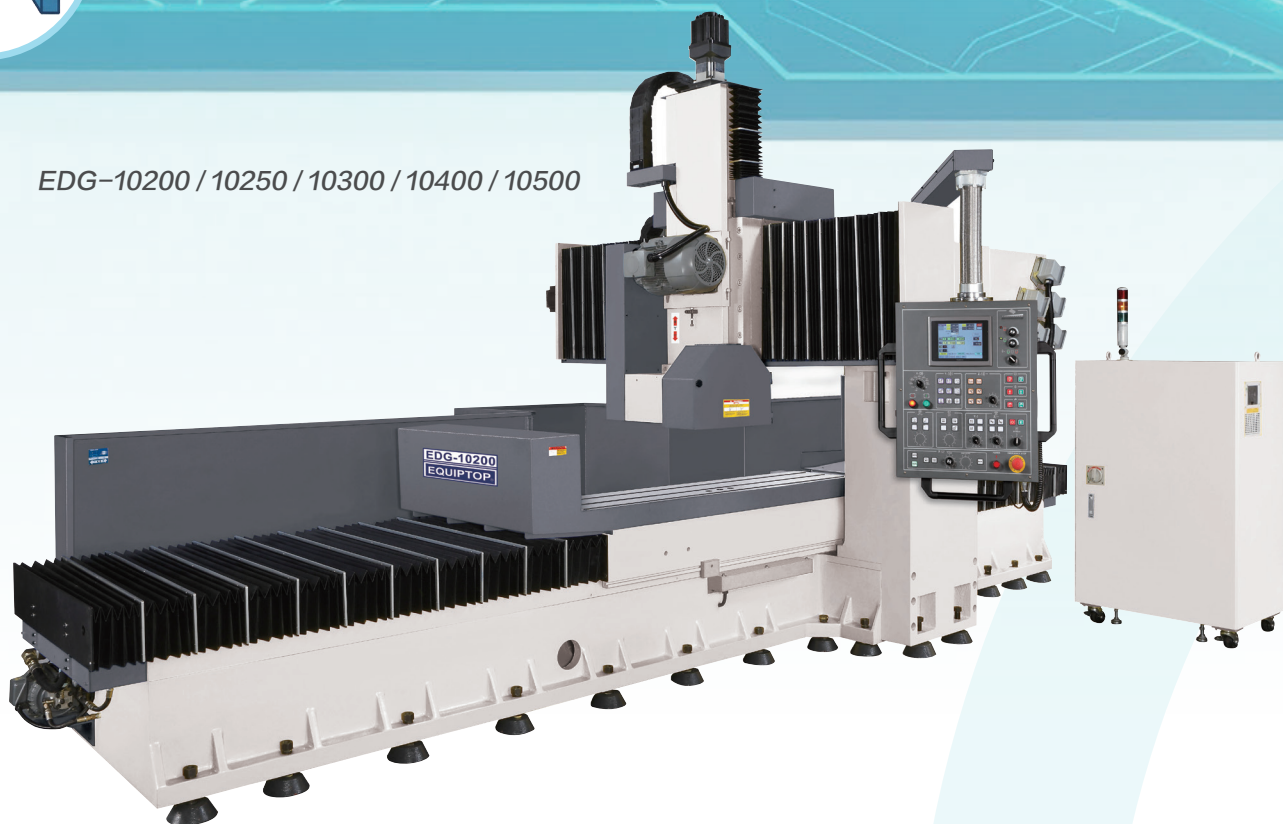

EDG-15300 / 15400 / 15500
汽缸配重搭配伺服煞車馬達裝置



English Version 中文版

Innovation Perfection Technology Value

創新設計 追求完美 引導科技 創造價值



AI

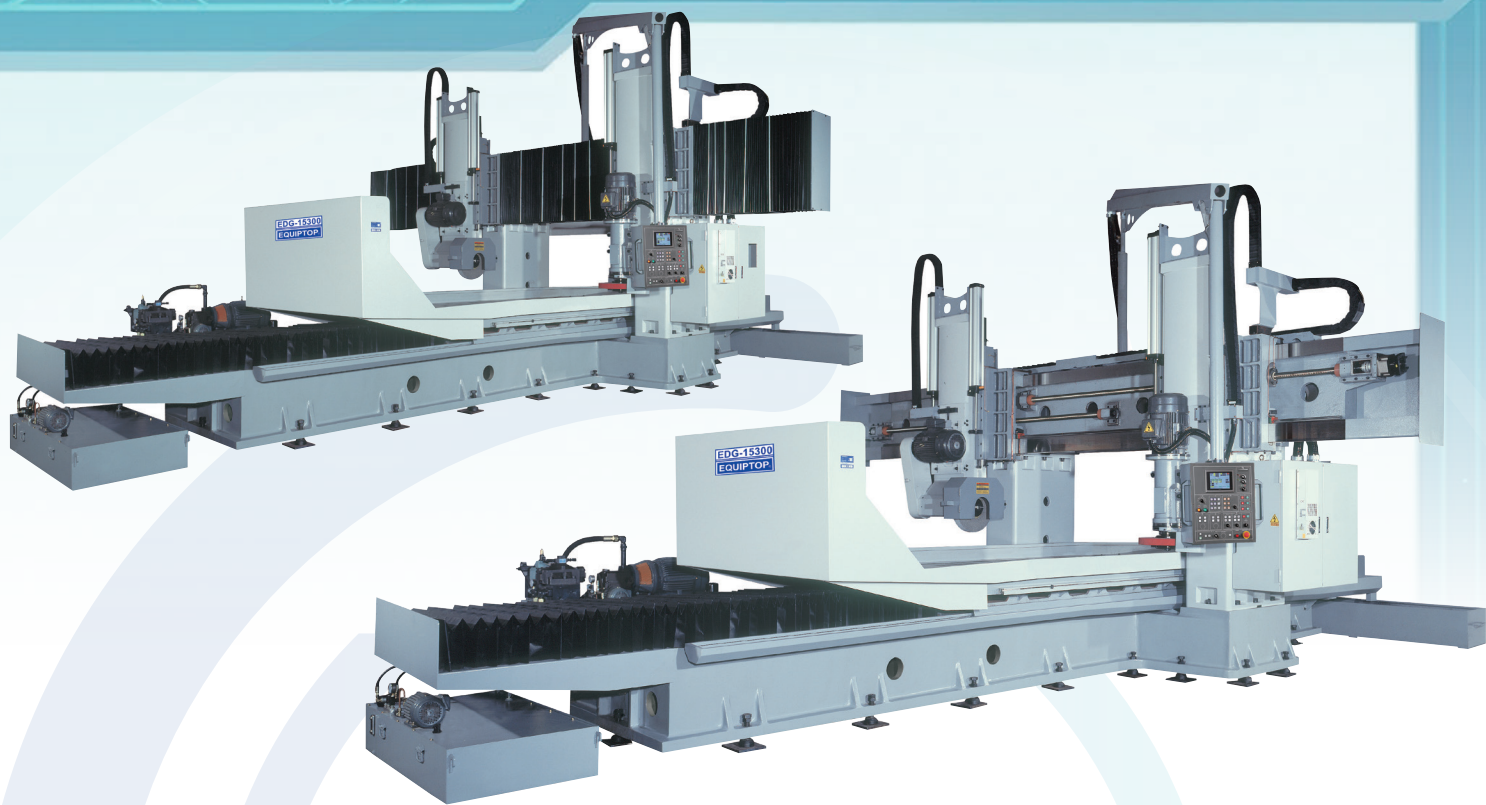

特殊選配

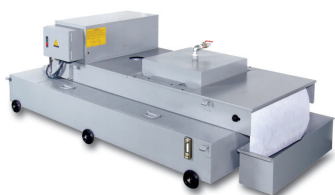

自動紙帶水機附磁性過濾器

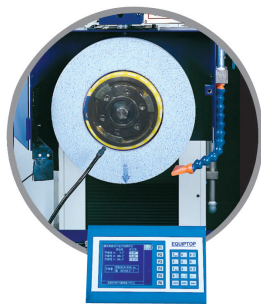

砂輪平衡校正儀



砂輪轂



工作燈



油壓油冷機



變頻器



平衡台



電磁盤(含磁力控制器)



ECG-CNC 高精密數控外圓磨床





English Version 中文版

Innovation Perfection Technology Value

創新設計 追求完美 引導科技 創造價值





集團品牌
Sister companies

FEELER[®]
VMX-1020
立式加工中心機



LEADWELL[®]
LTC-200
車銑複合式車床

ECOCA[®]
SL-8MCSY
CNC 多工複合車銑
切削中心



Taiwan Grinding Machine Manufacturer **Seeking Canadian Distributor**

Surface & Cylindrical Grinder **Manufacturer - Partnership Opportunity**

Dear Sir / Madam,

I came across your company while searching for machinery distributors in Canada and was impressed by your product portfolio and market presence.

Equiptop Hitech Corp. is a Taiwan-based manufacturer with over 37 years of experience producing surface grinders, cylindrical grinders, rotary grinders, and vertical machining centers. We are also a sister company of the FFG Group, one of the world's largest machine tool manufacturers.

We are currently looking for experienced distribution partners in Canada to expand the market for our grinding machines.

If this opportunity is of interest, we would be glad to introduce our products and discuss potential cooperation.

Please find our e-brochure attached. You may also visit our website for more information:

www.equiptop.com.tw (<http://www.equiptop.com.tw>)

We look forward to your reply.

Best regards,

Equiptop Hitech Corp.



ffg-equiptop.com

AI 客服 AI sales : equiptopaikm888.com

EQUIPTOP



EQUIPTOP GAI

Waiting for you 期待與您相遇 ...

Answer for you 答君所問



友嘉集團
FAIR FRIEND GROUP



眾程科技
EQUIPTOP HITECH CORP.



工具機產業節能銀標章
Silver Label for Energy Conservation in the Machine Tool Industry



工具機產業 AI 賦能金標章
AI-enabled Gold Medal for the Machine Tool Industry



台灣精品 2022
Taiwan Excellence 2022



經濟部創新研究獎
Taiwan Enterprises Innovation Award



眾程科技股份有限公司
EQUIPTOP HITECH CORP.

<https://ffg-equiptop.com>

421016 臺中市后里區三豐東路 88 號
NO.88 SAN FENG E. RD., HOULI DISTRICT,
TAICHUNG CITY, TAIWAN 421016

電話 : +886-4-2557-6060
傳真 : +886-4-2557-9677
郵箱 : equiptop@hibox.hinet.net

品質至上
Innovation

研究創新
Perfection

永續經營
Technology

團隊第一
Value